

CLASS II

EROSION CONTROL  
PERMIT

&

STANDARD DETAILS



City of Champaign  
Engineering Division  
702 Edgebrook Drive  
Champaign, IL 61820  
Phone 217-403-4710  
Fax 217-403-4755

Date Received _____ Permit Number _____
Site Visit Date _____
Permit Fee _____ Check No. _____
<i>Permit Fees - \$100 for Residential and \$200 for Commercial Make check payable to City of Champaign</i>

**CLASS II LAND DISTURBANCE PERMIT FORM**  
**(Land Disturbances between 2,000 square feet and one (1) acre)**

**1. APPLICANT** (Please check if applicant is the landowner or designated agent\*)

Name	Landowner	Designated Agent*	
_____			
Address _____			
City	State	Zip Code	Area Code/Telephone Number

**2. LANDOWNER**

Name _____			
Address _____			
City	State	Zip Code	Area Code/Telephone Number

**3. LOCATION**

Subdivision Name _____			
Subdivision Lot No.   Tax ID Number _____			
Street Address _____			

**4. PROJECT TYPE**

(Circle one):	Residential	Commercial
---------------	-------------	------------

**5. NAME AND TELEPHONE NUMBER OF ON-SITE RESPONSIBLE PERSON**

Name	Area Code/Telephone Number
------	----------------------------

I (we) affirm that the above information is accurate and that I (we) will conduct the above described earth change in accordance with Part 91 Soil Erosion and Sedimentation Control, of the Natural Resource and Environmental Protection Act, 1994 PA. No. 451 as amended, applicable local ordinances, and the documents accompanying this application.

I (we) request the City's Erosion Control Inspector to inspect and approve work completed in accordance with the approved Erosion and Sediment Control Plan.

\_\_\_\_\_  
Landowner's Signature

Print Name

Date

\_\_\_\_\_  
Designated Agent's Signature

Print Name

Date

**6. SOIL EROSION AND SEDIMENTATION CONTROL PLAN**

Attach applicable standard detail(s) to the application form.

# CLASS II EROSION CONTROL PERMIT

## STANDARD

---

EROSION CONTROL PRACTICES FLOW CHART	1
SAMPLE EROSION CONTROL PLAN # 1	2
SAMPLE EROSION CONTROL PLAN # 2	3
SAMPLE EROSION CONTROL PLAN # 3	4
GENERAL NOTES	5
STABILIZED LOT ENTRANCE	6
PERIMETER CONTROLS	
SEDIMENT FENCE	8
GRASS BUFFER STRIP	10
INLET PROTECTION	
STONE BAG INLET PROTECTION	12
MANUFACTURED INLET PROTECTION PRODUCTS	14
CONCENTRATED FLOW CONTROLS	
CHECK DAMS - ROCK CHECK DAM	16
DOWNSPOUT EXTENDER	18
EROSION CONTROL BLANKET	20
SODDING	24

# CLASS II EROSION CONTROL PERMIT

## EROSION CONTROL PRACTICES FLOW CHART

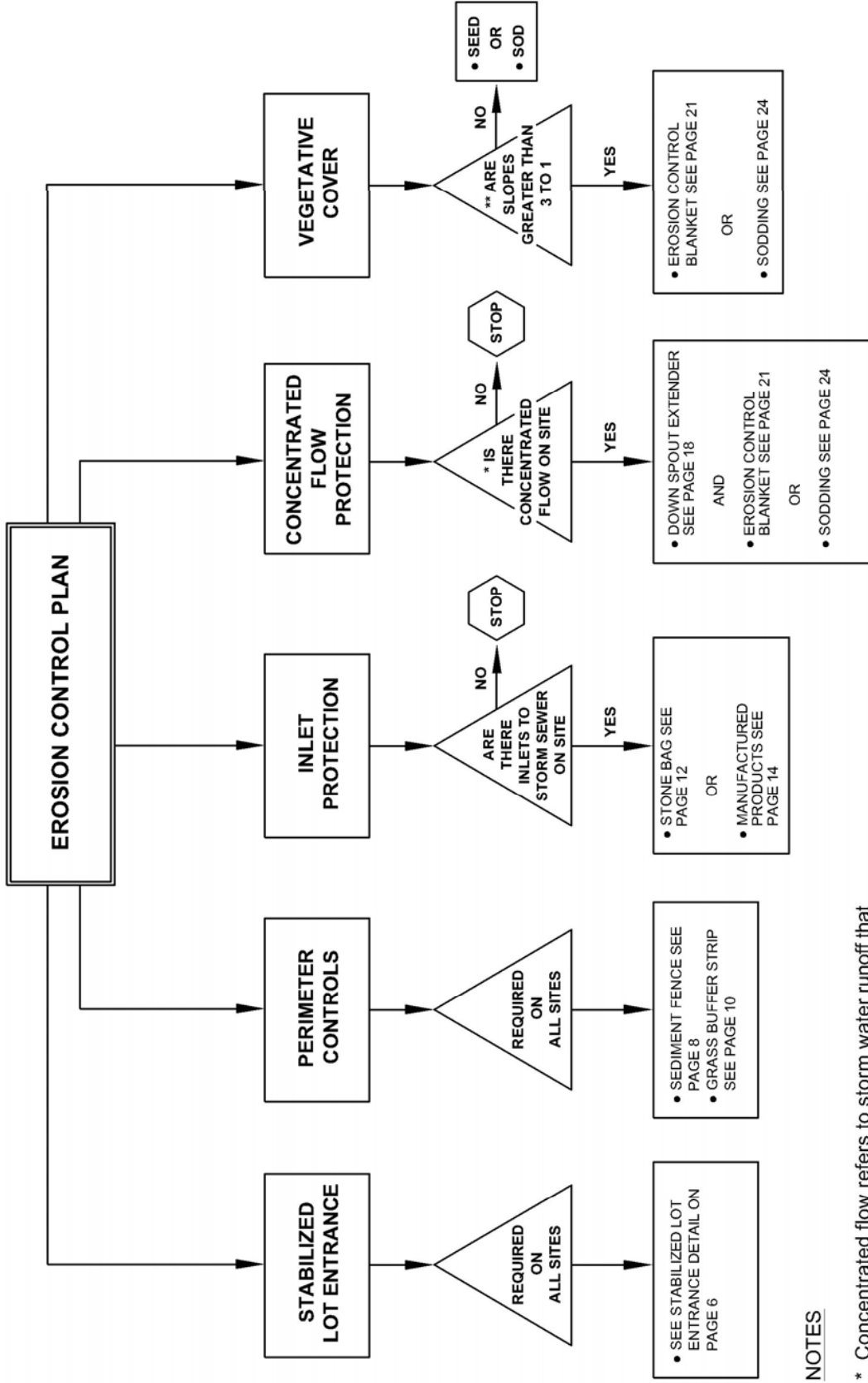

### NOTES

\* Concentrated flow refers to storm water runoff that has been concentrated and is flowing through small depressions, rills, gullies, ditches or swales.

\*\* 3 to 1 refers to 3 feet horizontal to 1 foot vertical on slopes.  $1 \frac{1}{3}$

# SAMPLE EROSION CONTROL PLAN DRAWING #1

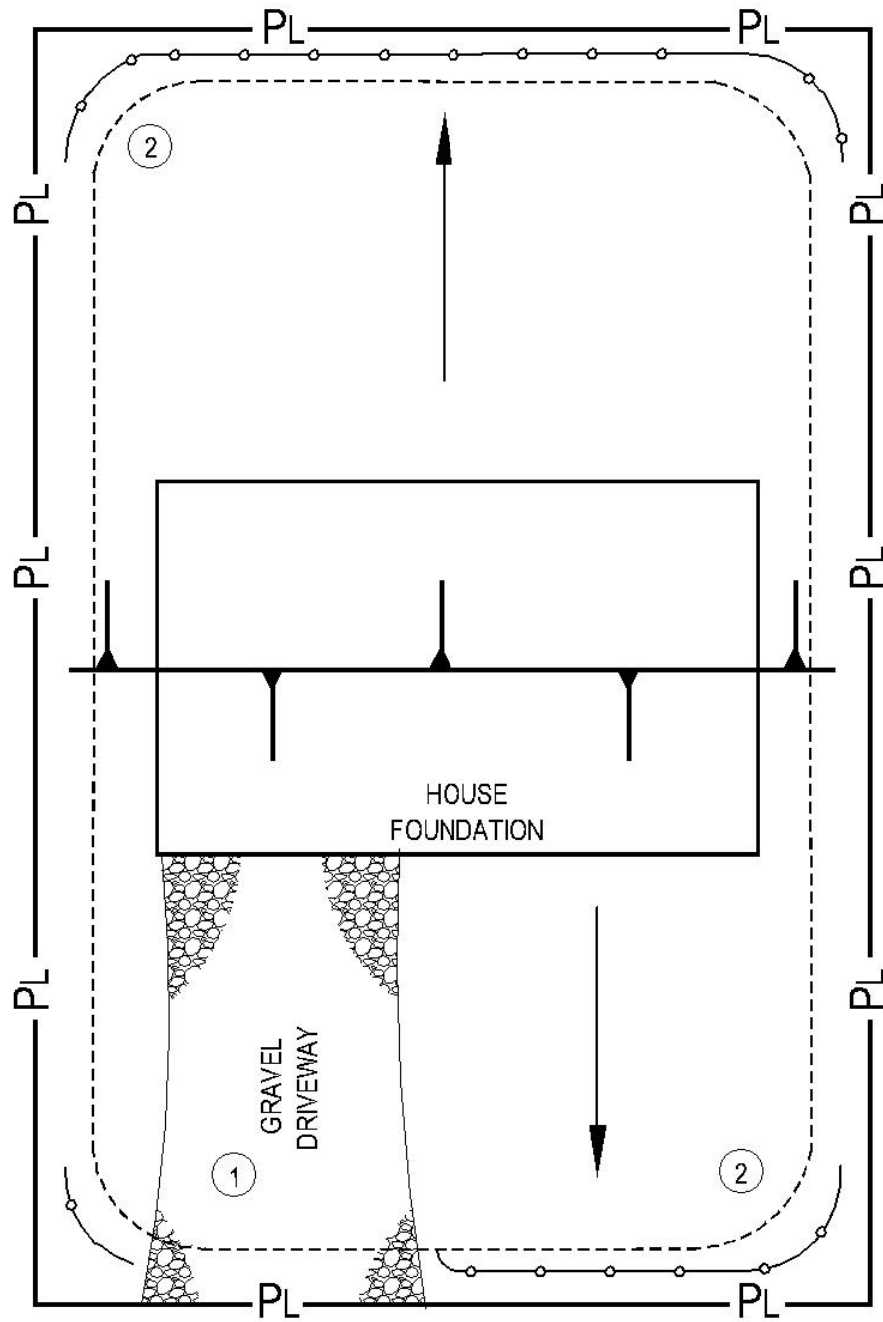

**LEGEND:**

- SEDIMENT BARRIER
- - - - - LIMITS OF DISTURBANCE
- ▲— DIRECTION OF SURFACE WATER RUNOFF
- ▲— TOP OF SLOPE INDICATOR

# SAMPLE EROSION CONTROL PLAN DRAWING #2

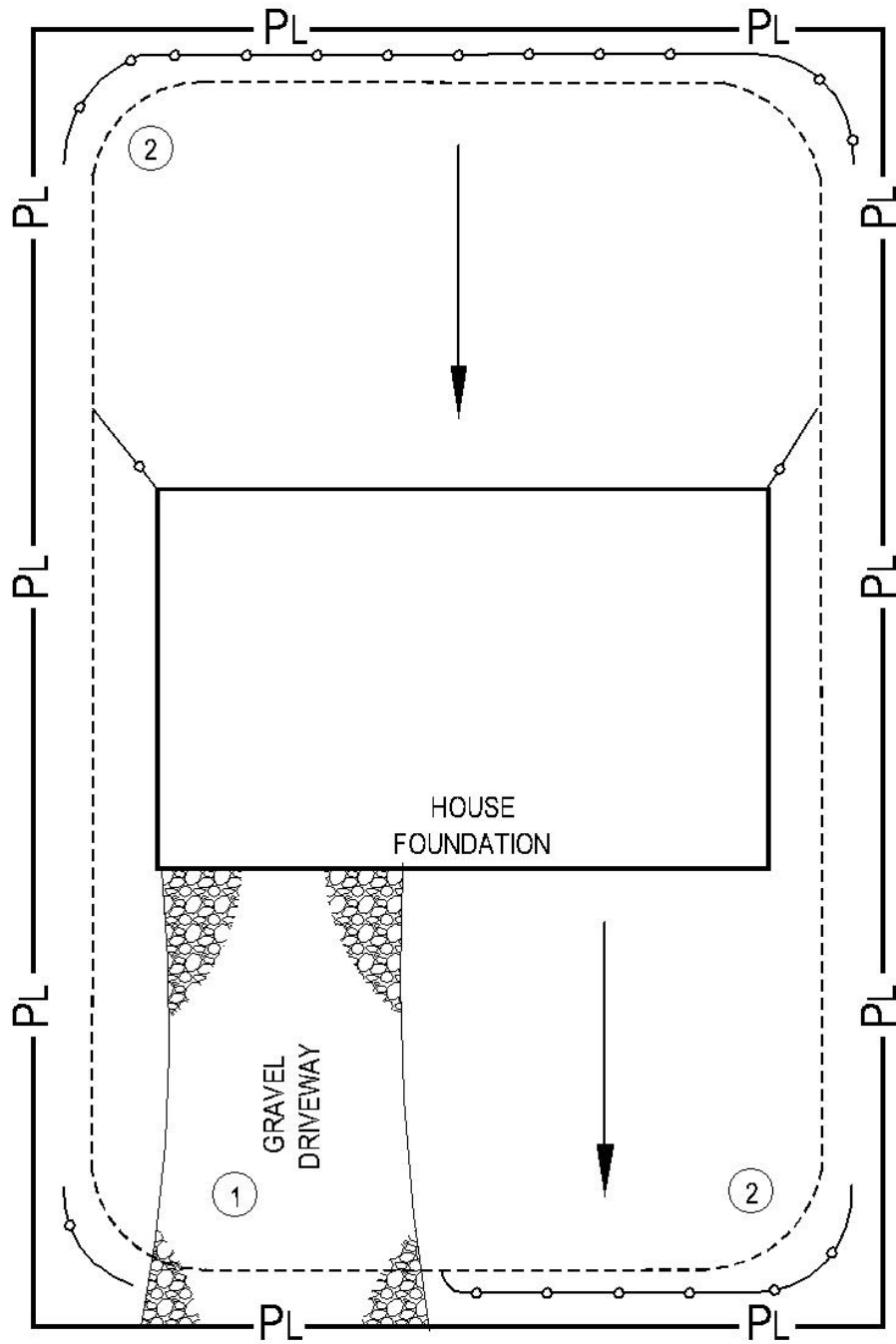



**LEGEND:**

- SEDIMENT BARRIER
- - - - - LIMITS OF DISTURBANCE
- ▲ DIRECTION OF SURFACE WATER RUNOFF

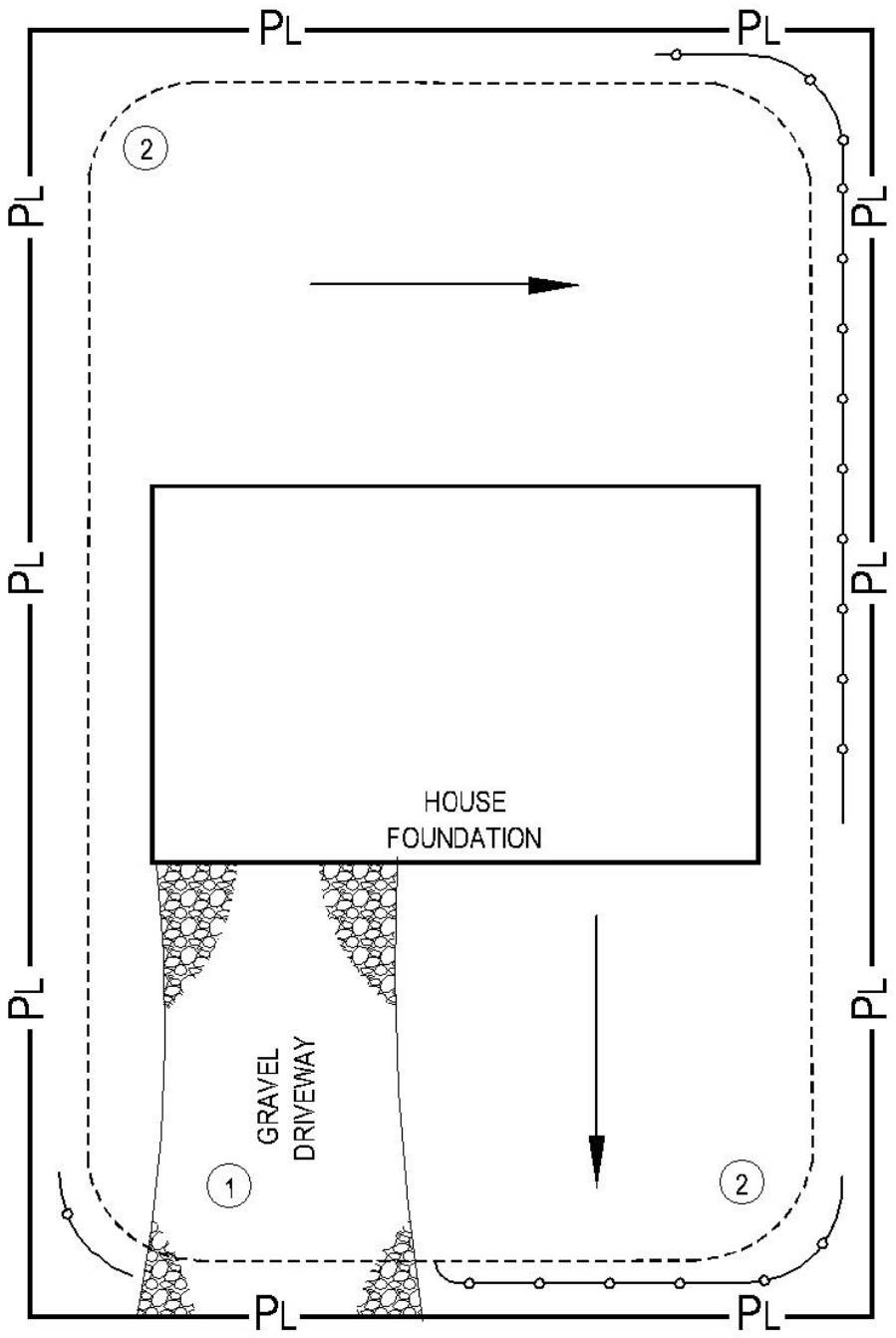
**SAMPLE EROSION CONTROL PLAN DRAWING #3**

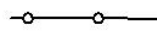

**LEGEND:**

-  SEDIMENT BARRIER
-  LIMITS OF DISTURBANCE
-  DIRECTION OF SURFACE WATER RUNOFF

**GENERAL INSTALLATION/CONSTRUCTION SEQUENCE:**

- 1.) Stabilized lot entrance
- 2.) Perimeter controls
  - Place where stormwater runoff leaves the site.
  - Inspect and maintain controls.
- 3.) Excavate and backfill foundations
  - Spoil pile must remain a minimum of 5 FT. from back of curb and do not extend beyond property line.
- 4.) Construction activities
  - Maintain and repair all controls until final certificate of occupancy is issued.
- 5.) Final grading and sod or seed placement.
- 6.) Perimeter controls removed
  - Remove after permanent ground cover is obtained at a density sufficient to control erosion.

**CONCENTRATED FLOW:**

- 1.) Provide (rocks) checks of erosion protection (erosion blanket, sod, etc.) for concentrated flow areas.
- 2.) Provide soil protection and energy dissipation at gutter downspouts if they are in place prior to full vegetative cover over the area.
- 3.) Provide inlet protection at all storm sewer inlets, grates, drains, and manholes.



**STABILIZED LOT ENTRANCE:**

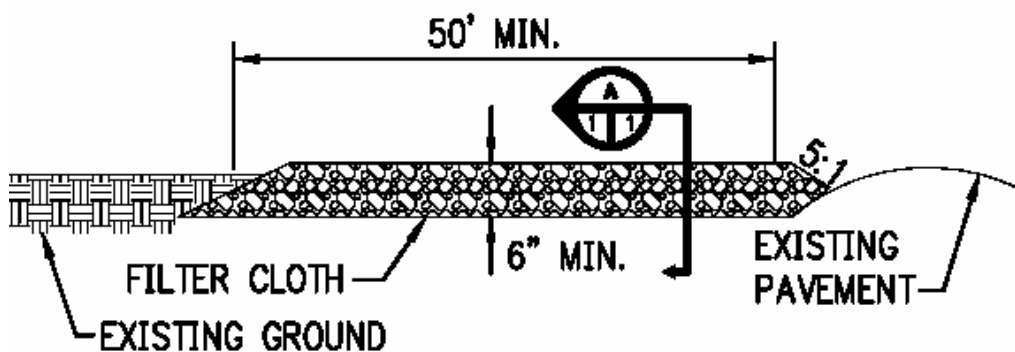

**SIDE ELEVATION**

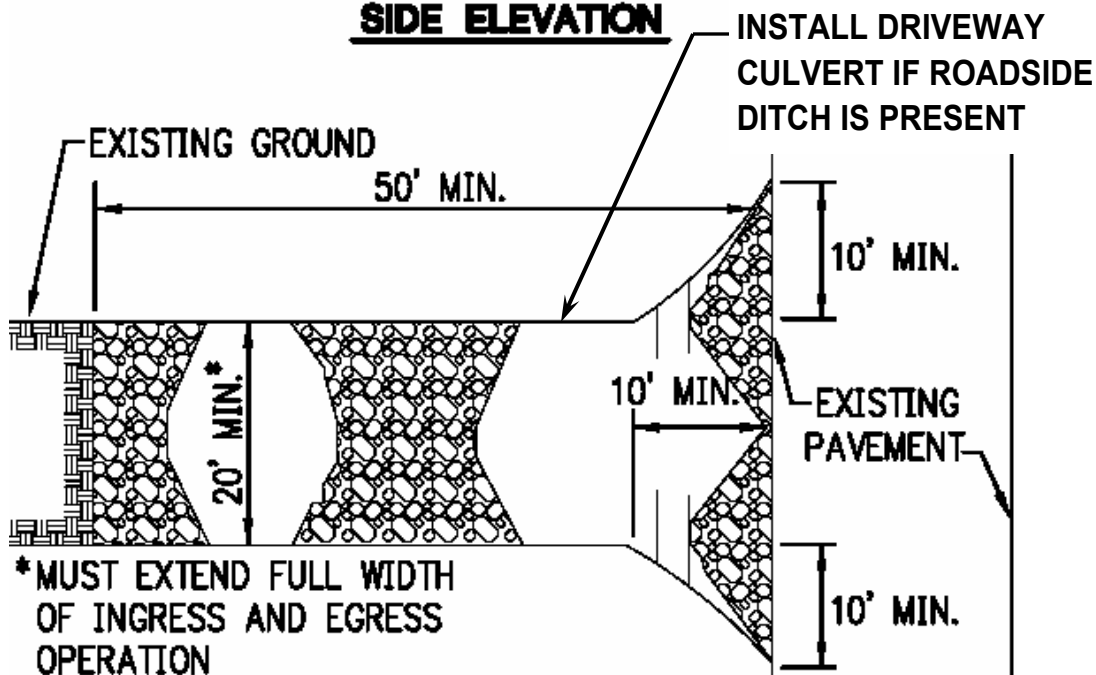

**PLAN VIEW**

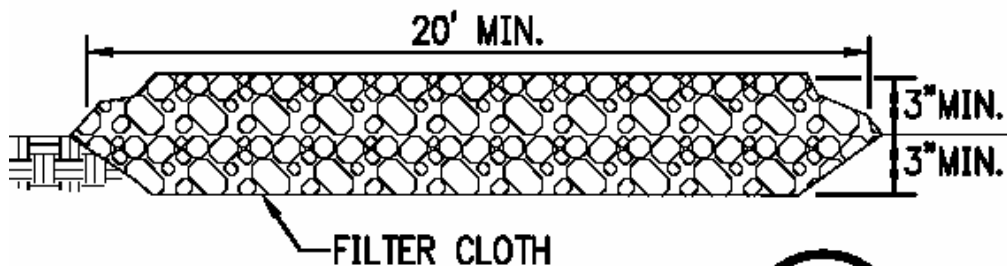

**SECTION**

NOT TO SCALE



**STABILIZED LOT ENTRANCE:**

**NOTES:**

Stabilized Entrance Material Can Be:

- 1.) 2-3 inches coarse aggregate.
- 2.) Wood chips or mulch.
- 3.) Turf reinforcement mat is sturdy enough for construction vehicle traffic.
- 4.) City approved material.

**MAINTENANCE:**

- 1.) Inspect on a daily basis or as necessary.
- 2.) Immediately remove mud or sediment tracked onto road.
- 3.) Add additional stabilized material as necessary.

### SEDIMENT FENCE

1. EXCAVATE A 6" X 4" TRENCH \*

\* SLICING MACHINE CAN ALSO BE USED.

2. SET THE STAKES ON THE DOWNSLOPE SIDE OF TRENCH.

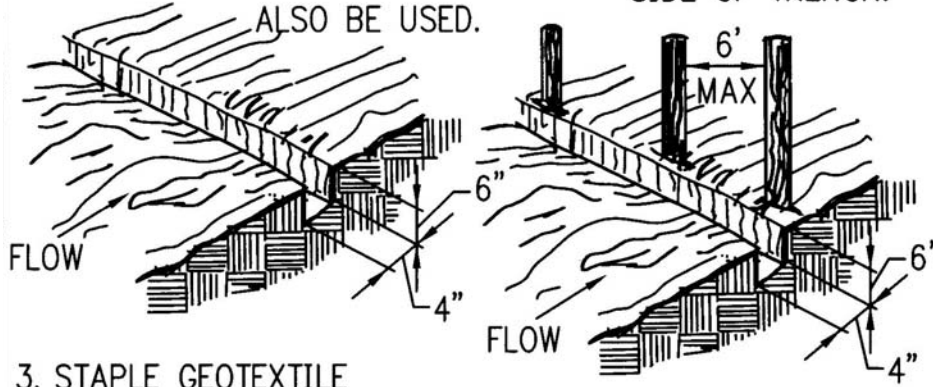

3. STAPLE GEOTEXTILE TO STAKES AND EXTEND IT INTO THE TRENCH.

4. BACKFILL AND COMPACT THE EXCAVATED SOIL.

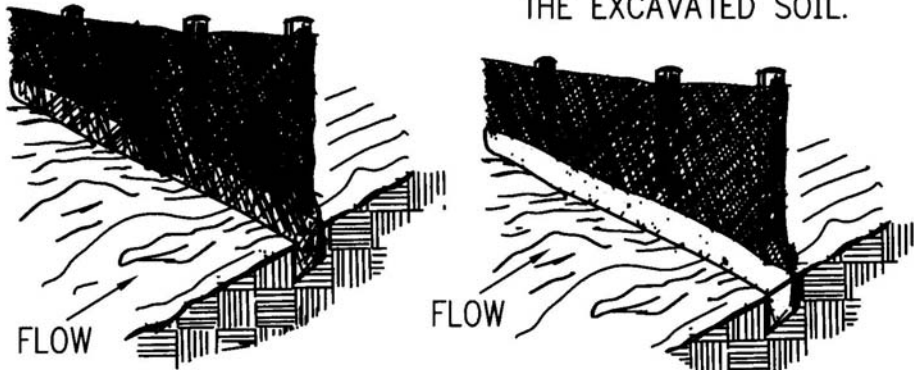

### SHEET PILE INSTALLATION

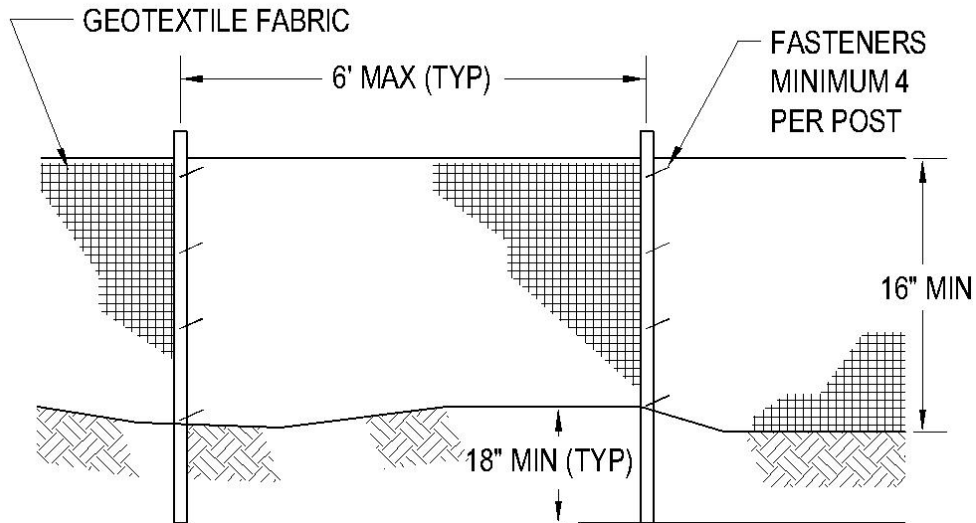

### ELEVATION

**SEDIMENT FENCE NOTES:**

**INSTALLATION:**

1. Sediment fence shall be a minimum of 16 inches above the original ground surface and shall not exceed 34 inches above ground surface.
2. Excavate a trench approximately 4 inches wide and 6 inches deep on the upslope side of the proposed location of the fence. A slicing machine may be used in lieu of trenching.
3. Posts shall be placed a maximum of 6 feet apart. Fabric shall be fastened securely to the upslope side of posts using min. One-inch long, heavy-duty wire staples or tie wires. Eight inches of the fabric shall be extended into the trench. The fabric shall not be stapled to existing trees.
4. The 4 inch by 6 inch trench shall be backfilled and the soil compacted over the textile unless a slicing machine is used.

**MAINTENANCE:**

1. Inspect on a daily basis or as necessary.
2. Any damage shall be repaired immediately.
3. Sediment must be removed when it reaches 6 inches high on the fence.
4. If geotextile has deteriorated due to ultraviolet breakdown, it shall be replaced.
5. Sediment fence shall be removed when it has served its useful purpose, but not before the upslope area has been permanently stabilized.

## GRASS BUFFER STRIP

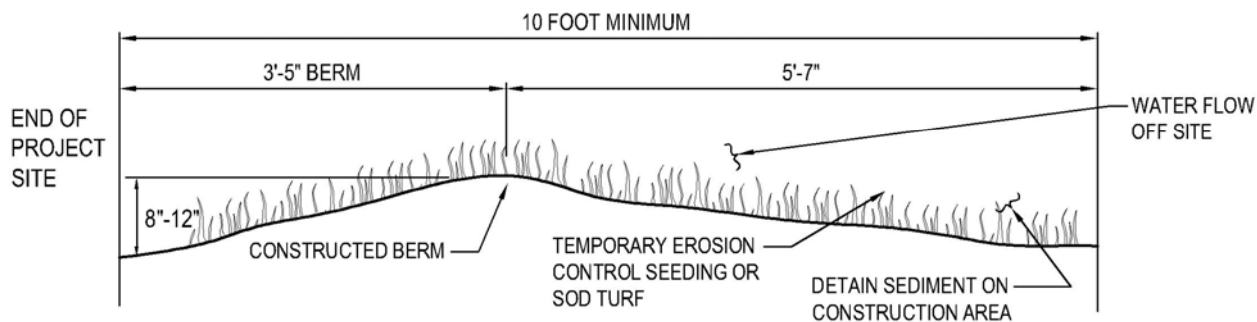
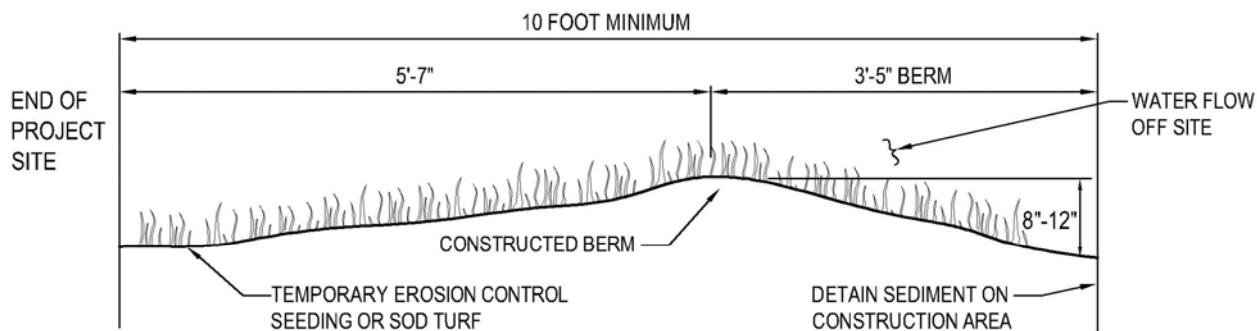

**NOTES**

1. STONE BAGS CAN BE USED IN LIEU OF CONSTRUCTED BERM. SEE PAGE 12
2. REMOVE SEDIMENTS WHEN COVER APPROXIMATELY 75 PERCENT OF THE VEGETATED FILTER STRIP.

## GRASS BUFFER STRIP

### DESCRIPTION:

These are wide strips of undisturbed vegetation consisting of grass or other erosion resistant plants surrounding the disturbed site. They provide infiltration, intercept sediment and other pollutants, and reduce stormwater flow and velocity. They can also act as a screen for visual pollution and reduce construction noise.

### PLANNING CONSIDERATIONS:

Grass strips should be fenced off prior to construction. Avoid storing debris from clearing and grubbing, and other construction waste material in these strips during construction.

### DESIGN CRITERIA:

The minimum length of strip must be at least as long as the contributing runoff area. The minimum width should conform to Table below.

MINIMUM WIDTHS OF FILTER STRIPS

SLOPE OF LAND %	WIDTH OF FILTER STRIP FOR GRASSED AREAS (FT)
0	10
2	12
4	14
6	16
8	18
10	20
15	25

### INSPECTION AND MAINTENANCE

1. Maintain moist soil conditions immediately after seeding and/or sod installation.
2. Maintain moist soil conditions throughout vegetation establishment period.
3. Sediment deposits should be removed after each storm event.

## STONE BAG INLET PROTECTION

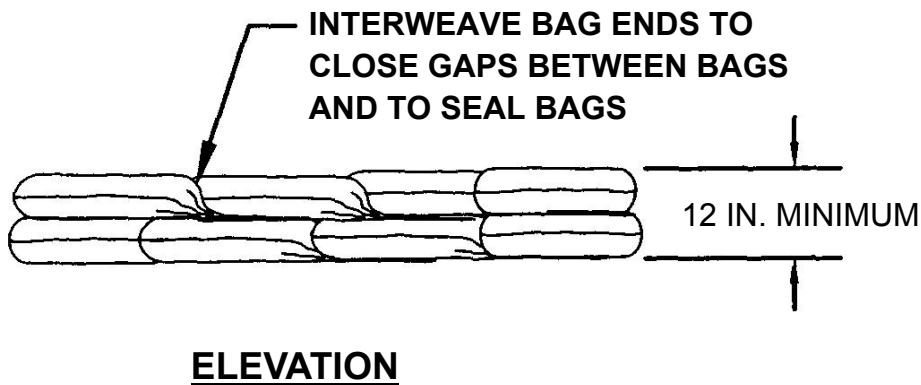
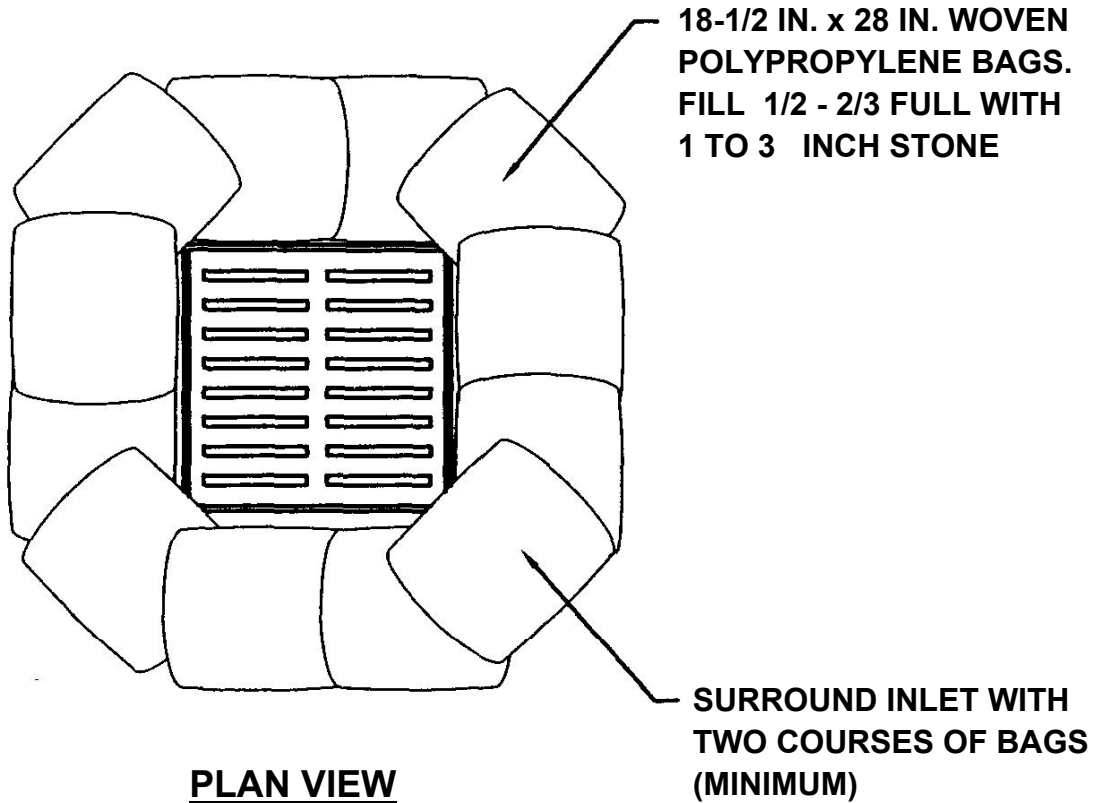

## **STONE BAG INLET PROTECTION**

### **INSTALLATION:**

1. Stone fill bags shall be woven polypropylene bags with approximate dimensions of 18.5 inches by 28 inches.
2. Bags shall be filled 1/2 to 2/3 full with 1 to 3 inch stone. The ends of filled bags using either draw strings or wire ties.
3. Interweave the loose ends of the bags so that gaps between bags are filled and ends of bags are sealed.
4. Completely surround inlet with a minimum of two rows of bags to minimum of 12 inches in height.

### **MAINTENANCE**

1. Inspect on a daily basis or as necessary.
2. Any damage to bags shall be repaired immediately.
3. Sediment must be remove when it reaches 3 inches high on bags.
4. If bags have deteriorated due to ultraviolet breakdown or wear and tear, they shall be replaced.
5. Inlet protection shall be remove when it has served its useful purpose, but not permanently stabilized.



## **MANUFACTURED INLET PROTECTION PRODUCTS**

---

THE FOLLOWING PRODUCTS ARE  
APPROVED FOR INLET PROTECTION

### **DANDY PRODUCTS INC**

2011 Harrisburg pike Suite R  
Grove city, OH 43123  
800-591-2284

[www.dandyproducts.com](http://www.dandyproducts.com)

### **ECO-BLOK**

1560-1 Newbury Rd Suite 102  
Newbury Park , CA  
91320-3448  
(805) 499-8856 Tel  
(805) 499-5797 Fax

[www.eco-blok.com](http://www.eco-blok.com)

CATCH-ALL INLET PROTECTOR

### **MARATHON MATERIALS, INC.**

25523 WEST SCHULTZ STREET  
PLAINFIELD, ILLINOIS 60544  
(630) 983-9494 Tel  
(800) 983-9493 Toll Free  
(630) 983-9580 Fax

[www.marathonmaterials.com](http://www.marathonmaterials.com)

OTHER PRODUCTS CAN BE SUBMITTED  
FOR REVIEW AND APPROVAL

## **MANUFACTURED INLET PROTECTION PRODUCTS**

---

### **INSTALLATION:**

All inlet protection products shall be installed in accordance with manufacturer's instructions.

### **MAINTENANCE**

1. Inspect on a daily basis or as necessary.
2. Any damage to products shall be repaired immediately.
3. Sediment must be removed when it reaches 1/3 the height of the product.
4. Inlet protection shall be removed when it has served its useful purpose, but not before upslope area has been permanently stabilized.

**ROCK CHECK DAM:**

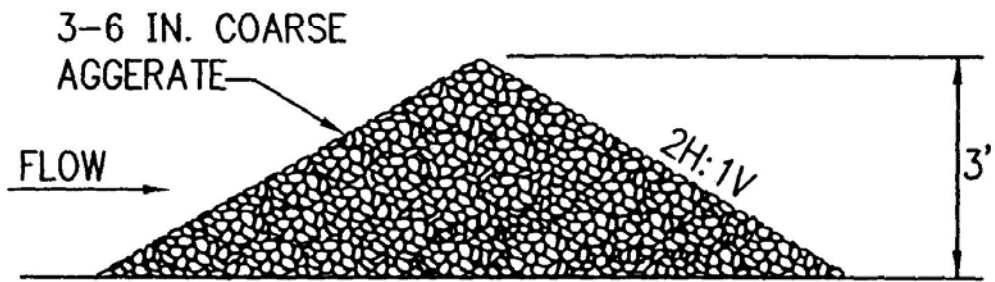
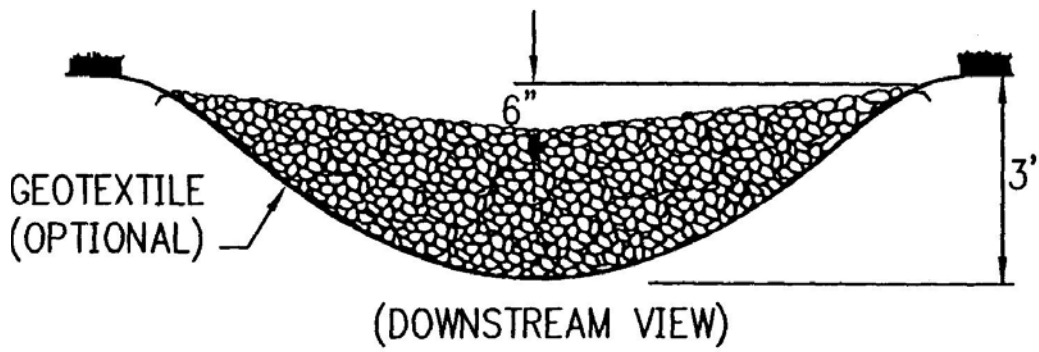

**SPACING BETWEEN CHECK DAMS:**

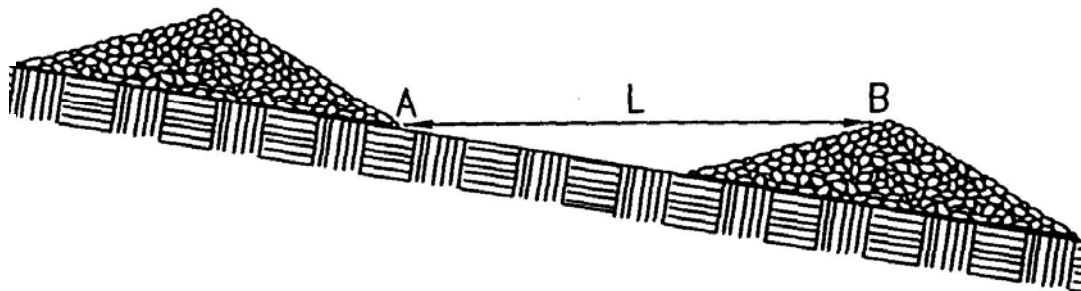

L = DISTANCE SUCH THAT POINTS  
A AND B ARE OF EQUAL ELEVATION.

**ROCK CHECK DAM:**

**NOTES:**

1. The maximum height of the dam shall be 3.0 feet.
2. The center of the check dam must be at least 6 inches lower than the outer edges.
3. For added stability, the base of the check dam can be keyed into the soil approximately 6 inches.
4. The dams should be spaced so the toe of the upstream dam is at the same elevation as the top of the downstream dam.
5. Stone should be placed according to the detail. Hand or Mechanical placement will be necessary to achieve complete coverage of the ditch or swale and to ensure that the center of the dam is lower than the edges.
6. Geotextile may be used under the stone to provide a stable foundation and to facilitate removal of the stone.
7. Check dams should be inspected for sediment accumulation after each runoff producing storm event. Sediment should be removed when it reaches half of the original height of the measure.
8. Regular inspection should be made to ensure that the center of the dam is lower than the edges. Erosion caused by high flows around the edges of the dam should be corrected immediately.

# DOWNSPOUT EXTENDER

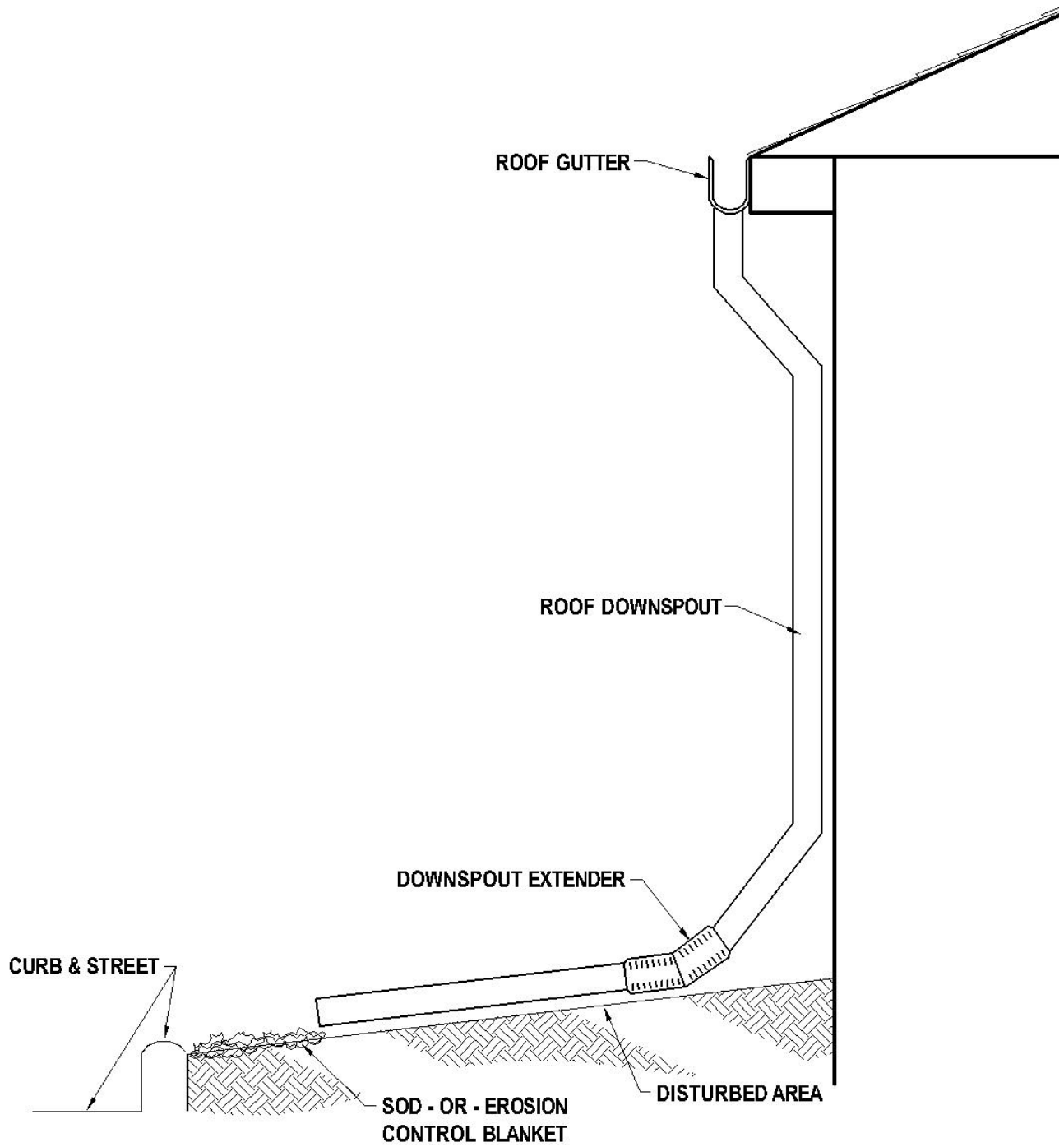

## **DOWNSPOUT EXTENDER**

### **DEFINITION:**

A downspout extender is a temporary tube or pipe used to convey water from a building's rain downspouts to a stable area.

### **PURPOSE:**

To prevent water discharged from a building's downspouts from eroding disturbed areas.

### **CONDITIONS WHERE PRACTICE APPLIES:**

On downspouts discharging to disturbed areas.

### **DESIGN CRITERIA AND REQUIREMENTS:**

- |           |  |
|-----------|--|
| Timing    | The downspout extender shall be installed as soon as downspouts are installed.   |
| Removal   | Downspout extenders may be removed only after the disturbed area is stabilized by permanent best management practices. |
| Materials | Non-slotted, non-perforated PVC or similar plastic pipe material should be used.                                       |

### **INSPECTION AND MAINTENANCE:**

Downspout extenders shall be inspected daily within 24 hours of the end of a storm that is 0.5 inches or greater during periods of prolonged rainfall and, minimally, at least once a week. Repair or replacement should be made immediately.

## EROSION CONTROL BLANKET

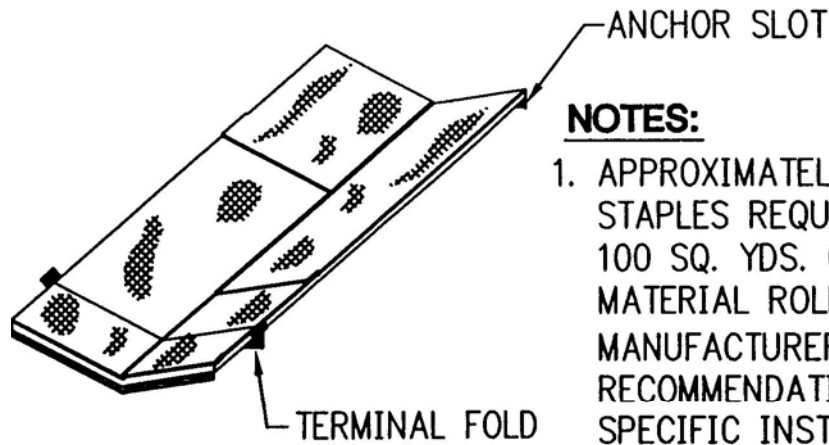

**NOTES:**

1. APPROXIMATELY 200 STAPLES REQUIRED PER 100 SQ. YDS. OF MATERIAL ROLL. CHECK MANUFACTURER'S RECOMMENDATIONS FOR SPECIFIC INSTALLATION AND STAPLING REQUIREMENTS.

12" MAX. 4H:1V OR FLATTER  
 6" MAX. STEEPER THAN 4H:1V

OVERLAP ENDS AND EDGES A MINIMUM OF 6 INCHES AND STAPLE EVERY 6 INCHES

5' MAX. 4H:1V OR FLATTER  
 3' MAX. STEEPER THAN 4H:1V

CHECK SLOT \*

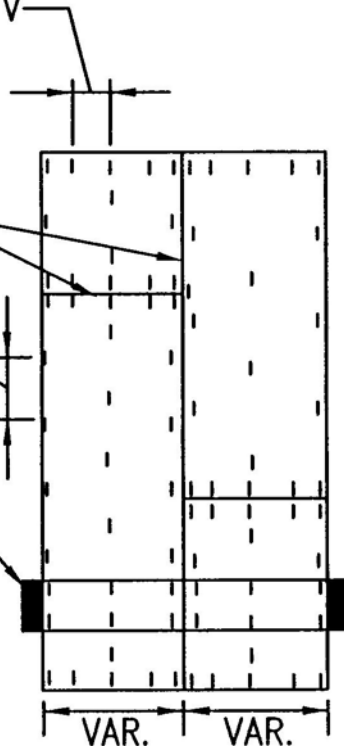

**PLAN VIEW**  
**STAPLING DIAGRAM:**

\* CHECK SLOTS AT MIN. 50' INTERVALS; NOT REQ'D WITH ALL "COMBINATION" BLANKETS.

## TYPICAL ORIENTATION OF EROSION CONTROL BLANKET

### SHALLOW SLOPE:



ON SHALLOW SLOPES, STRIPS OF PROTECTIVE COVERINGS MAY BE APPLIED PARALLEL TO DIRECTION OF FLOW.

### BERM:



WHERE THERE IS A BERM AT THE TOP OF THE SLOPE, BRING THE MATERIAL OVER THE BERM AND ANCHOR IT BEHIND THE BERM.

### STEEP SLOPE:

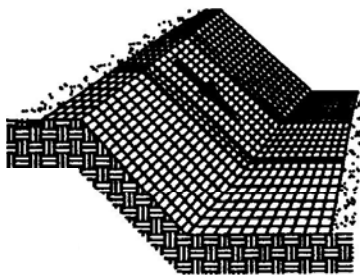

ON STEEP SLOPES, APPLY PROTECTIVE COVERING PERPENDICULAR TO THE DIRECTION OF FLOW AND ANCHOR SECURELY.

### STEEP SLOPE:



BRING MATERIAL DOWN TO A LEVEL AREA BEFORE TERMINATING INSTALLATION. TURN THE END UNDER 4" AND STAPLE AT 12" INTERVALS.

### DITCH:

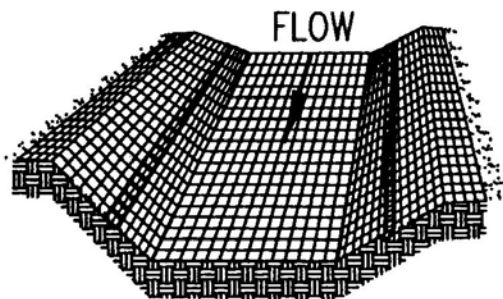

IN DITCHES, APPLY PROTECTIVE COVERING PARALLEL TO THE DIRECTION OF FLOW. AVOID JOINING MATERIAL IN THE CENTER OF THE DITCH IF AT ALL POSSIBLE.



## **EROSION CONTROL BLANKET**

### **LAYING AND STAPLING:**

Place the erosion control blanket on a friable seedbed free of clods, rocks, and roots that might impede good contact.

1. Start placing the protective covering from the top of the channel or slope and unroll down-grade.
2. Allow to rest loosely on soil; do not stretch.
3. Upslope ends of the protective covering should be buried in an anchor slot no less than 6 inches deep. Tamp earth firmly over the material. Staple the material at a minimum of every 12 inches across the top end.
4. Edges of the material shall be stapled every 3 feet. The multiple widths are placed side by side, the adjacent edges shall be overlapped a minimum of 6 inches and stapled together. Staples shall be placed down the center, staggered with the edges at 3 foot intervals.

### **NOTE:**

Study manufacturer's recommendations and site conditions for correct installation and stapling of product.

## **EROSION CONTROL BLANKET NOTES (CONTINUED):**

### **JOINING PROTECTIVE COVERINGS:**

Insert a new roll of material into an anchor slot as with upslope ends. Overlap the end of the previous roll a minimum of 12 inches, and staple across the end of the roll just below the anchor slot and across the material every 12 inches.

### **TERMINAL END:**

Where the material is discontinued or where the ends under 4 inches, and staple across end every 12 inches.

### **AT BOTTOM OF SLOPES:**

Roll onto a level surface before anchoring, turn ends under 4 inches, and staple across end every 12 inches.

### **FINAL CHECK:**

These installation criteria must be met:

1. Protective blanket is in uniform contact with the soil.
2. All lap joints are secure.
3. All staples are driven flush with the ground.
4. All disturbed areas have been seeded.

### **MAINTENANCE:**

All soil stabilization blankets and matting should be inspected periodically following installation, particularly after storms, to check for erosion and undermining. Any dislocation or failure should be repaired immediately. If washouts or breakage occurs, reinstall the material after repairing damage to the slope or ditch. Continue to monitor these areas until they become permanently stabilized; at that time an annual inspection should be adequate.

**SODDING:**



INCORRECT



CORRECT

**NOTE:**

LAY SOD IN A STAGGERED PATTERN. BUTT THE STRIPS TIGHTLY AGAINST EACH OTHER. DO NOT LEAVE SPACES AND DO NOT OVERLAP. A SHARPENED MASON'S TROWEL IS A HANDY TOOL FOR TUCKING DOWN THE ENDS AND TRIMMING PIECES.

**BUTTING:**

ANGLED ENDS CAUSED BY THE AUTOMATIC SOD CUTTER MUST BE MATCHED CORRECTLY.



ROLL SOD IMMEDIATELY TO ACHIEVE FIRM CONTACT WITH THE SOIL.

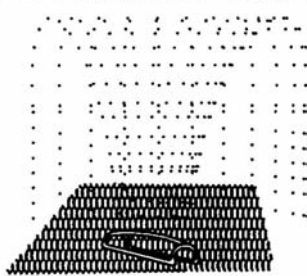

WATER SOD TO A DEPTH OF 4" AS NEEDED. WATER WELL AS SOON AS THE SOD IS INSTALLED.



MOW WHEN THE SOD IS ESTABLISHED - IN 2-3 WEEKS. SET THE MOWER HEIGHT AT 2"-3".

**APPEARANCE OF GOOD SOD:**

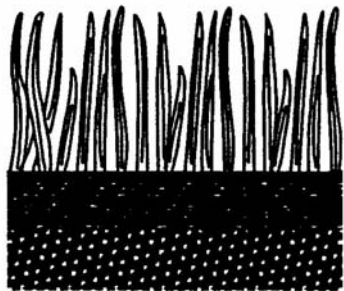

**SHOOTS:**

GRASS SHOULD BE GREEN AND HEALTHY, MOWED AT A 2"-3" CUTTING HEIGHT.

**THATCH:**

GRASS CLIPPINGS AND DEAD LEAVES UP TO 1/2" THICK.

**ROOT ZONE:**

SOIL AND ROOTS SHOULD BE 1/2" - 3/4" THICK WITH DENSE ROOT MAT FOR STRENGTH.

